



Fulham Prep School

Health and Safety Handbook



elliswhittam

Employment Law / HR / Health & Safety

CONTENTS

INTRODUCTION

HEALTH AND SAFETY POLICY STATEMENT

RESPONSIBILITIES AND RULES

Employees
Pupils

HEALTH AND SAFETY RULES

General
Working Practices
Hazard / Warning Signs and Notices
Working Conditions / Environment
Protective Clothing and Equipment
Fire Precautions
Accidents
Health
School Transport
Rules Covering Gross Misconduct

ARRANGEMENTS FOR HEALTH AND SAFETY

Accident, Incident and Ill-Health Recording, Reporting and Investigation
Asbestos
Communication and Consultation
Disabled Persons including pupils with Special Educational Needs (SEN)
Display Screen Equipment (Computers)
Display Screen Equipment (DSE)/Visual Display Unit (VDU)
Drivers
Drugs and Alcohol
Electricity
Electrical Safety
Fire
First Aid
Gas Installations and Appliances
Hazardous Substances (COSHH)
Infection Control
Interactive Whiteboards
Ladders and Stepladders
Legionnaires Disease
Lone Workers
Manual Handling
Needlestick or Sharps Injuries
New and Expectant Mothers
Personal Protective Equipment
Safeguarding
Smoking
Stress
Supporting Pupils with Medical Needs
Temporary Staff and Volunteers
Training
Violence to Staff
Visitors
Work At Height
Work Equipment

HEALTH AND SAFETY HANDBOOK ACKNOWLEDGEMENT FORM

INTRODUCTION

This handbook contains the health and safety information you require to comply with our Health and Safety Policy. After reading it you will be required to sign to confirm that it has been brought to your attention. If you have any queries regarding the contents please do not hesitate to ask.

Fulham Prep School takes its responsibility for health and safety very seriously and is committed to a programme of progressive improvement that requires input from all its employees. If you see anything during your work that gives rise to a concern you are positively encouraged to report it to your manager.

Safety is everyone's responsibility and that includes you.

HEALTH AND SAFETY POLICY STATEMENT

The management of **Fulham Prep School** recognises that it has a legal duty of care towards protecting the health and safety of its employees, pupils and others who may be affected by the school's activities.

In order to discharge its responsibilities the management of the school will:

- bring this Policy Statement to the attention of all employees
- carry out and regularly review risk assessments to identify proportionate and pragmatic solutions to reducing risk
- communicate and consult with our employees on matters affecting their health and safety
- comply fully with all relevant legal requirements, codes of practice and regulations at International, National and Local levels
- eliminate risks to health and safety, where possible, through selection and design of materials, buildings, facilities, equipment and processes
- encourage staff to identify and report hazards so that we can all contribute towards improving safety
- ensure that emergency procedures are in place at all locations for dealing with health and safety issues
- maintain our premises, provide and maintain safe plant and equipment
- only engage contractors who are able to demonstrate due regard to health & safety matters
- provide adequate resources to control the health and safety risks arising from our work activities
- provide adequate training and ensure that all employees are competent to do their tasks
- provide an organisational structure that defines the responsibilities for health and safety
- provide information, instruction and supervision for employees
- regularly monitor performance and revise policies and procedures to pursue a programme of continuous improvement.

This Health and Safety Policy will be reviewed at least annually and revised as necessary to reflect changes to the school activities and any changes to legislation. Any changes to the Policy will be brought to the attention of all employees.

Signed:

Dated:

Principal

Signed:

Dated:

Chief Operating Officer

RESPONSIBILITIES AND RULES

The Governors, Principal, senior staff and designated health and safety staff will take all reasonable steps to identify and reduce hazards to a minimum. To assist in this all staff and pupils must be aware of their own and others personal safety, and in any of the schools activities, both on and off site.

Employees

All employees must:

- take reasonable care of their own safety
- take reasonable care of the safety of others affected by their actions
- observe the safety rules
- comply with the Health and Safety Policy
- conform to all written or verbal instructions given to them to ensure their personal safety and the safety of others
- dress sensibly and safely for their particular working environment or occupation
- conduct themselves in an orderly manner in the work place and refrain from any antics or pranks
- use all safety equipment and/or protective clothing as directed
- avoid any improvisations of any form which could create an unnecessary risk to their personal safety and the safety of others
- maintain all equipment in good condition and report defects to their supervisor
- report any safety hazard or malfunction of any item of plant or equipment to their supervisor
- report all accidents to their supervisor whether an injury is sustained or not
- attend as requested any health and safety training course
- observe all laid down procedures for processes, materials and substances used
- observe the fire evacuation procedure and the position of all fire equipment and fire exit routes.

Pupils

All pupils must:

- co-operate with Teachers and school staff on health and safety matters;
- not interfere with anything provided to safeguard their own health and safety;
- take reasonable care of their own health and safety; and
- report all health and safety concerns to a Teacher.

HEALTH AND SAFETY RULES

General

- It is the duty of all employees to co-operate with the Board of Governors in fulfilling our legal obligations in relation to health and safety.
- Employees must not intentionally or recklessly interfere with anything provided in the interests of health, safety or welfare.
- Employees are required to notify to management of any unsafe activity, item or situation.

Working Practices

- Employees must not operate any item of plant or equipment unless they have been trained and authorised.
- Employees must make full and proper use of all equipment guarding.
- Employees must not clean any moving item of plant or equipment.
- Employees must not make any repairs or carry out maintenance work of any description unless authorised to do so.
- Employees must use all substances, chemicals, liquids etc, in accordance with all written instructions.
- Employees must not smoke except in prescribed areas.

Hazard / Warning Signs and Notices

- Employees must comply with all hazard/warning signs and notices displayed on the premises.

Working Conditions / Environment

- Employees must make proper use of all equipment and facilities provided to control working conditions/ environment.
- Employees must keep stairways, corridors, classrooms and work areas clear and in a clean and tidy condition.
- Employees must dispose of all rubbish, scrap and waste materials using the facilities provided.
- Employees must clear up any spillage or liquids in the prescribed manner.
- Employees must deposit all waste materials and substances at the correct disposal points and in the prescribed manner.

Protective Clothing and Equipment

- Employees must use all items of protective clothing/equipment provided as instructed.
- Employees must store and maintain protective clothing/equipment in the approved manner.
- Employees must report any damage, loss, fault or unsuitability of protective clothing/equipment to their supervisor.

Fire Precautions

- Employees must comply with all laid down emergency procedures.
- Employees must not obstruct any fire escape route, fire equipment or fire doors.
- Employees must not misuse any fire fighting equipment provided.
- Employees must report any use of fire fighting equipment to their supervisor.

Accidents

- Employees must seek medical treatment for work related injuries they receive by contacting a designated first aider. Upon returning from treatment they must report the incident to their supervisor.
- Employees must ensure that any accident or injury treatment is properly recorded in the Accident Book.
- Employees must notify management of any incident in which damage is caused to property.

Health

- Employees must report to management any medical condition or medication which could affect the safety of themselves or others.
- Employees must co-operate with the management on the implementation of the medical and occupational health provisions.

School Transport

- Drivers must carry out prescribed checks of vehicles prior to use and in conjunction with the laid down checking procedure.
- Employees must not drive or operate any vehicles for which they do not hold the appropriate driving licence or permit.
- Employees must not carry unauthorised passengers or unauthorised loads.
- Employees must not use vehicles for unauthorised purposes.
- Employees must not load vehicles above the stated capacity.
- Employees must not drive or operate vehicles whilst suffering from a medical condition or illness that may affect their driving or operating ability.
- Employees must not drive whilst using a mobile phone or any other electronic device.

Rules Covering Gross Misconduct

An employee will be liable to summary dismissal if they are found to have acted in any of the following ways:

- A serious or wilful breach of Safety Rules.
- Unauthorised removal or interference with any guard or protective device.
- Unauthorised operation of any item of plant or equipment.
- Unauthorised removal of any item of first aid equipment.
- Wilful damage to, misuse of or interference with any item provided in the interests of Health and Safety or welfare at work.
- Unauthorised removal or defacing of any label, sign or warning device.
- Horseplay or practical jokes which could cause accidents.
- Making false statements or in any way deliberately interfering with evidence following an accident or dangerous occurrence.
- Misuse of any item of equipment, utensil, fitting/ fixture, vehicle or electrical equipment.
- Deliberately disobeying an authorised instruction.

ARRANGEMENTS FOR HEALTH AND SAFETY

Accident, Incident and Ill-Health Recording, Reporting and Investigation

If you have an accident whilst in the course of carrying out your work, you must report the accident, however small, to a First Aider. **The First Aiders are:**

First aid boxes are sited around the school in the following locations:

You must ensure details of the accident are recorded in the **Accident Book**, which is kept at:

First Aid Room

All staff must make themselves familiar with the location of the nearest first aid point, the names of the first aid personnel and the location of the Accident Book.

All near misses must also be reported to the Principal as soon as possible so that action can be taken to investigate the causes and to prevent recurrence.

Definitions

An **accident** is an unplanned event that causes injury to persons, damage to property or a combination of both.

A **near miss/incident** is an unplanned event that does not cause injury or damage but could do so.

A **work-related illness** is a prescribed illness that is obtained by an employee through the course of work or from a non-employee as a result of activities carried out by the school.

Asbestos

The school will protect employees, pupils and other persons potentially exposed to asbestos as far as is reasonably practicable. Everyone who needs to know about the presence of asbestos will be alerted. No one will be allowed to start any work that could disturb asbestos unless the correct procedures are to be employed.

Where a problem arises relating to the condition of asbestos-containing material, the employee must inform the Bursar.



Communication and Consultation

The school has established effective lines of communication so as to involve and consult our employees.

These include:

- individual conversations
- notice boards
- internal publications
- staff meetings
- Health and Safety meetings.

In addition the school displays the 'Health and Safety Law – What You Need To Know' poster on the Notice Board.



Disabled Persons including pupils with Special Educational Needs (SEN)

The school will give full and proper consideration to the needs of disabled employees, pupils and visitors.

To achieve this, the school will:

- treat all disabled employees, pupils and visitors with respect and dignity, both in the provision of a safe working environment and in equal access to the school's facilities
- ensure that risk assessments are undertaken of the special needs of the disabled and carry out reasonable adjustments to the premises and/or employment arrangements
- encourage employees with special needs to suggest any premises or task improvements to their line managers
- discipline any employees found treating their disabled colleagues with less than the expected standards of respect and dignity
- in an emergency evacuation, ensure suitable plans are in place which will assist disabled people to leave the premises swiftly.

Display Screen Equipment (Computers)

All reasonable steps will be taken by the school to secure the health and safety of employees who work with display screen equipment.

This policy is aimed at those who regularly use DSE, known as 'Users':

- a) for continuous periods of more than one hour *and*
- b) for more than 2½ hours per day

Typically this will therefore apply to administrative functions, the teaching of computer skills and other prolonged users. You will be advised if your post allows you to be classed as a 'User'.

The school will carry out an assessment of each user's workstation and implement necessary measures to remedy any risks found as a result of the assessment.

Eye Tests and Corrective Appliances

The school will arrange for the provision of free eye tests when requested and at regular intervals thereafter or where a visual problem is experienced, at no cost to the employee. Where employees require corrective appliances specifically for use with display screen equipment, the school will arrange for the supply of spectacles, free of charge, or up to current cost limit of £XX.

Training

Employees working with display screen equipment (DSE) should comply with the instructions and training given regarding safe workstation set-up and use, including the need for regular changes of activity or breaks and the use of the equipment provided.

Health

Employees should inform their manager of any disability or health condition which may affect their ability to work using display screen equipment or be affected by working with DSE. In addition they should also report any discomfort or health concern believed to be associated with the use of DSE. Any health information will be treated confidentially.

Display Screen Equipment (DSE)/Visual Display Unit (VDU)

Some practical tips:

Getting Comfortable

- Adjust your chair and VDU to find the most comfortable position for your work. As a broad guide, your lumbar should be supported by the seat cushion, forearms should be approximately horizontal and your eyes the same height as the top of the VDU.
- Make sure you have enough work space to take whatever documents or other equipment you need.
- Try different arrangements of keyboard, screen, mouse and documents to find the best arrangement for you. A document holder may help you avoid awkward neck and eye movements.
- Arrange your desk and VDU to avoid glare, or bright reflections on the screen. This will be easiest if neither you nor the screen is directly facing windows or bright lights. Adjust curtains or blinds to prevent unwanted light.
- Make sure there is space under your desk to move your legs freely. Move any obstacles such as boxes or equipment.
- Avoid excess pressure from the edge of your seat on the backs of your legs and knees. A footrest may be helpful, particularly for smaller users.

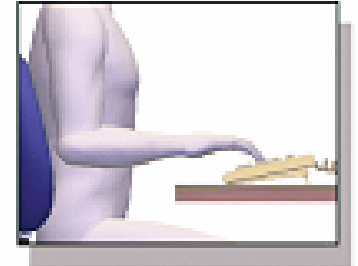
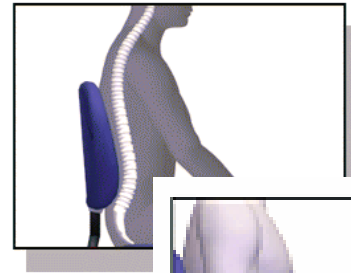

Keying in

- Adjust your keyboard to get a good keying position. A space in front of the keyboard is sometimes helpful for resting the hands and wrists when not keying.
- Try to keep your wrists straight when keying. Keep a soft touch on the keys and don't overstretch your fingers. Good keyboard technique is important.

Using a mouse

- Position the mouse within easy reach, so it can be used with the wrist straight. Sit upright and close to the desk, so you don't have to work with your mouse arm stretched. Move the keyboard out of the way if it is not being used.
- Support your forearm on the desk, and don't grip the mouse too tightly.
- Rest your fingers lightly on the buttons and do not press them hard.

Reading the screen

- Adjust the brightness and contrast controls on the screen to suit lighting conditions in the room.
- Make sure the screen surface is clean.

- In setting up software, choose options giving text that is large enough to read easily on your screen, when you are sitting in a normal, comfortable working position. Select colours that are easy on the eye (avoid red text on a blue background, or vice-versa).
- Individual characters on the screen should be sharply focused and should not flicker or move. If they do, the VDU may need servicing or adjustment.

Posture and Breaks

- Don't sit in the same position for long periods. Make sure you change your posture as often as practicable. Some movement is desirable, but avoid repeated stretching to reach things you need (if this happens a lot, rearrange your workstation).
- Most jobs provide opportunities to take a break from the screen, e.g. to do filing or photocopying. Make use of them. If there are no such natural breaks in your job, your employer should plan for you to have rest breaks. Frequent short breaks are better than fewer long ones.

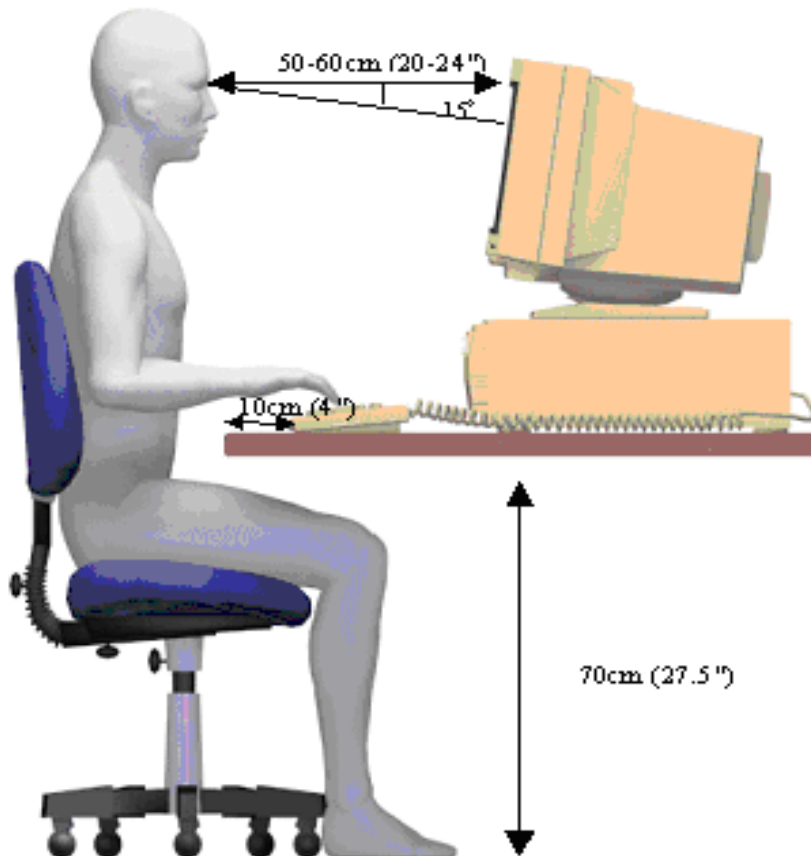

Drivers

Drivers will remain responsible for their safety and others and must comply with the Highway Code and Road Traffic Act.

It is the responsibility of drivers to inform the school of:

- anything that could affect their driving e.g. health conditions or injuries, use of prescribed medication
- changes to licence such as limitations, offences recorded, period bans
- vehicle defects that affect ability / safety to drive
- any accidents / incidents that occurred whilst driving on behalf of the school.

Before driving, drivers must

- review the need to travel
- have a valid licence for the vehicle they are driving
- carry out a pre-use vehicle check
- allow sufficient time to drive allowing for traffic, poor weather and rest breaks
- ensure sufficient rest
- be physically fit, with zero alcohol level and not under the influence of drugs that may affect the ability to drive
- adjust their driving position, head restraints and mirrors to ensure maximum comfort and safety.

Whilst driving, drivers must

- drive in accordance with the applicable law and with consideration for the safety of passengers and other road users
- take regular rest breaks every 2-3 hours or at first signs of tiredness
- remain in control of the vehicle at all times
- not smoke
- not use a mobile phone or other electronic device.

Minibus Driver Training

The absolute minimum requirements to comply with our insurance are that the drivers:

- are over the age of 21,
- have category D1 on their licence,
- have at least two years experience as a qualified driver
- hold a current full driving licence with no more than 6 penalty points. If a driver has less than 6 points, the driver may still be precluded if the points are for dangerous driving.

Prior to transporting pupils for the first time, all drivers will be given the opportunity of either a vehicle familiarisation session to include:

- Daily vehicle checks
- Pre-journey checks
- General driving safety
- Road testing
- Emergency stop
- Use of mirrors and indicators
- Reversing using mirrors only
- Passenger safety
- Passenger comfort.

All new drivers will be added to the list of authorised minibus drivers.

Staff who passed the test to drive a car after 1st January 1998 are required to successfully complete a PSV test to drive the minibus.

Drivers Hours

It is the school's policy that if there is a trip which involves a driver being in charge on an extended day, then a second adult should accompany the party and that person should be competent to share the driving to reduce the possibility of driver fatigue. An extended day is anything beyond 7.00 pm when the teacher started work at 8.45 am. This requirement is non-negotiable.

Driver's Responsibilities

Whilst the school will ensure a weekly check of the condition of the minibuses, drivers are responsible for completing the following checks before embarking on their trips:

- do a visual inspection of the minibuses which includes tyre pressure checks and that the windscreen and glass is clean and can be seen through
- check brakes to see that they are functioning correctly
- Ensure that mirrors and seat are in the correct driving position
- check that all lights are functioning correctly
- ensure that all seat belts are being worn. This includes all passengers, who must wear a seat belt
- ensure that the windscreen washer system works and that wipers are functioning correctly
- ensure that the vehicle is correctly loaded and that no more than sixteen passengers are being carried
- emergency exits must not be blocked
- ensure that all doors are correctly closed
- check that you have enough fuel for your journey
- as soon as possible after moving off, the driver should carry out a running brake test and at the same time, check the operation of the seat belts
- at intervals throughout the journey, all instruments and warning lights should be checked and necessary action taken if a fault is indicated
- ensure that food and drink are not consumed on the vehicle
- make sure that no rubbish is left on the vehicle and ensure that no malicious damage has occurred to the interior of the vehicle.

At the end of the journey the driver must lock and make the vehicle secure. Keys should only be taken just prior to making use of the minibuses. The keys should be returned immediately after use.

Passenger Responsibilities

- should wear seat belts and always remain in their seats until instructed otherwise
- should never distract the driver by shouting, etc
- pupils should not eat or drink on the vehicle
- must make sure that escape routes are not blocked by bags, etc
- pupils are ambassadors of the academy and must never bring its name into disrepute by gesturing, etc
- passengers found to have vandalised the minibuses may face a ban from using it again and be required to pay for damages.

Accident Procedures

If an accident occurs and any personal injury or damage to third party property is involved, then the driver must stop. He/she must be prepared to give his name and address and details of the owner of the vehicle to a Police Officer or any other person having reasonable grounds to ask. If for any reason the driver is not able to give these details then he/she must report in person to a Police Station as soon as practically possible, otherwise an offence is committed, and in any event not later than twenty-four hours afterwards.

Report the accident immediately to the school and complete the appropriate forms for onward transmission to our insurers.

Breakdown and Recovery

The minibuses are covered for breakdown and recovery. Details of how to contact the provider and our membership numbers are in the minibus.

First Aid

All minibuses contain first aid boxes which are checked at the end of each term. The contents of these boxes include:

- Antiseptic wipes
- Bandages
- Assorted adhesive dressings
- Plasters
- Eye pads
- Scissors.

Any use of the first aid kit must be reported as soon as possible thereby maintaining a full kit at all times.

Minibuses must not be used for private use.

Weekly Checks

Weekly checks of the minibuses will be carried out and recorded.

Staff who notice any defects in the minibuses should immediately notify the nominated person who will then determine whether or not the vehicle should be taken off the road and repairs carried out.

The minibuses are inspected every ten weeks and serviced in line with the manufacturers recommendations.

Incorrect Use of the Minibuses

A driver who breaks the speed limit will be responsible for paying his/her own fines. Similarly fines imposed for incorrect car parking or negligent driving will be the responsibility of the driver. Any damage caused to the minibuses through incorrect use, may result in the driver being asked to contribute fully or partially to any excess payable by the academy.

Speed Limits

The speed limit for minibuses is as follows:

- 30 mph not 40 mph on urban carriageways
- 50 mph not 60 mph on single carriageways
- 60 mph not 70 mph on dual carriageways
- 70 mph on motorways.

List of Authorised Drivers

The Academy will keep a list of drivers who have been authorised to drive the minibuses.

Authorisation may be withdrawn at any time by the Principal. Any member of staff who has been advised not to drive their own vehicle for medical reasons must advise the school immediately.

Drugs and Alcohol

Alcohol

Staff must not drink alcohol on school premises without express permission from a senior manager or director.

Any employee who is found consuming alcohol on school premises without permission or is found to be intoxicated at work will normally face disciplinary action on the ground of gross misconduct under the school's disciplinary procedure.

Drugs and medication

The possession, use or distribution of drugs for non-medical purposes on school premises is strictly forbidden and a gross misconduct offence.

If you are prescribed drugs by your doctor which may affect your ability to perform your work you should discuss the problem with your manager.

If the school suspects there has been a breach of this policy or your work performance or conduct has been impaired through substance abuse, the school reserves the right to require you to undergo a medical examination to determine the cause of the problem.

Medical Examination

Existing and prospective members of staff may be asked to undergo a medical examination, which will seek to determine whether he/she has taken a controlled drug or has an alcohol abuse problem.

A refusal to give consent to such an examination or a refusal to undergo the screening will result in the immediate withdrawal of any offer made to prospective staff and will normally be treated as gross misconduct for current members of staff.

If, having undergone a medical examination, it is confirmed that you have been positively tested for a controlled drug, or you admit there is a problem, the school reserves the right to suspend you from your employment (with or without pay) to allow the school to decide whether to deal with the matter under the terms of the school's disciplinary procedure and/or to require you to undergo treatment and rehabilitation.

Reasonable Grounds

The school reserves the right to search you or any of your property held on school premises at any time if there are reasonable grounds to believe that this policy is being or has been infringed or for any other reason. If you refuse to comply with these search procedures, your refusal will normally be treated as gross misconduct.

The school reserves the right to inform the police of any suspicions it may have with regard to the use of controlled drugs by its staff on the school's premises.

Electricity

All reasonable steps will be taken to secure the health and safety of employees, volunteers and pupils who use electrical equipment.

Employees must:



- visually check electrical equipment for damage before use
- report any defects found to the Principal
- not use defective electrical equipment
- not carry out any repair to any electrical item unless qualified to do so
- switch off non-essential equipment from the mains when left unattended for long periods
- not bring any electrical item onto school premises until it has been tested and a record of such a test has been included in the appropriate record
- not leave electric cables in such a position that they will cause a tripping hazard or be subject to mechanical damage
- never run extension leads under carpets or through doorways
- not daisy-chain extension leads to make a longer one
- not use adapter sockets – devices that plug into mains sockets to increase the number of outlets.

Electrical Safety

What are the hazards?

The main hazards are:

- contact with live parts causing shock / burns (normal mains voltage, 230 volts AC, can kill)
- faults which could cause fires
- fire or explosion where electricity could be the source of ignition in a potentially flammable or explosive atmosphere, e.g. in a spray paint booth.

Ensure that:

- suspect or faulty equipment is taken out of use, labelled 'DO NOT USE' and kept secure until examined by a competent person
- where possible, equipment, tools and power socket-outlets are switched off before plugging in or unplugging
- equipment is switched off and/or unplugged before cleaning or making adjustments.

Visual checks on electrical equipment

1. Inspections and testing of all portable electrical equipment and the fixed electrical installations is the responsibility of the school, though the responsibility for undertaking visual checks falls to all employees.

2. Around 95% of all faults or damage can be found by visual checks and this will involve checking:

- for damage to the cable covering, such as cuts and abrasions, apart from light scuffing, or non-standard repairs e.g. cable wrapped with electrical tape



- where the cable enters the plug. Internal wires - those covered by the outer sheath may be exposed or the cable may be loose and move within the plug

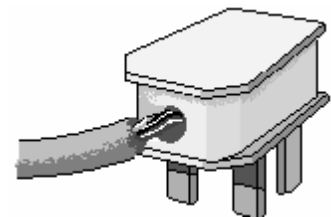

- for damage to the plug, such as cracked casing, bent pins, evidence of overheating i.e. burn marks or discoloration



- for damage to the sockets, switches, etc. e.g. cracked or broken casing
- that equipment has been used in conditions for which it is not suitable, e.g. a wet or dusty workplace or has damage to the outer cover of the equipment or has obvious loose parts or screws
- cables are routed safely, with one extension lead used per socket. Where there is a risk of tripping over cables and they cannot be re-routed, cable strips must be fitted.

Fire

All reasonable steps will be taken to prevent a fire occurring. In the event of fire, the safety of life will override all other considerations, such as saving property and extinguishing the fire.

The school does not require persons to attempt to extinguish a fire but extinguishing action may be taken if it is safe to do so. Immediate evacuation of the building must take place as soon as the evacuate signal is given. All occupants, on evacuation, should report to the pre-determined assembly points.

Re-entry of the building is strictly prohibited until the fire brigade officer or a senior person present declares it is safe to do so.

Employees are encouraged to report any concerns regarding fire procedures so the organisation can investigate and take remedial action if necessary.

You should familiarise yourself with the location of the fire alarms, fire appliances, fire exits and assembly points.

Fire Extinguisher Chart

Extinguisher		Type of Fire					Special Notes
Colour	Type	Solids (wood, paper, cloth, etc)	Flammable Liquids	Flammable Gases	Electrical Equipment	Cooking Oils & Fats	
 Red	Water	✓ Yes	✗ No	✗ No	✗ No	✗ No	Dangerous if used on 'liquid fires' or live electricity.
 Cream	Foam	✓ Yes	✓ Yes	✗ No	✗ No	✓ Yes	Not practical for home use.
 Canary Yellow	Wet Chemical	✗ No	✗ No	✗ No	✗ No	✓ Yes	Cooking Oils & Fats
 Blue	Dry Powder	✓ Yes	✓ Yes	✓ Yes	✓ Yes	✗ No	Safe use up to 1000v.
 Black	Carbon Dioxide (CO2)	✗ No	✓ Yes	✗ No	✓ Yes	✓ Yes	Safe on high and low voltages.
 White	Dry Water Mist	✓ Yes	✓ Yes	✓ Yes	✓ Yes	✓ Yes	Safe to use on up to 35kV

First Aid

Guidelines on Responding to Injuries

Minor injuries

The following injuries are considered minor and capable of being dealt with by a first aider in school: Grazes, small scratches, bumps, minor bruising, minor scalding or burns resulting in slight redness to the skin.

Injuries requiring medical attention:

- Deep cut
- Long cuts. Long cuts are considered to be approximately 1 inch when on the hand or foot and 2 inches when elsewhere on the body.
- The cut is jagged.
- The injury involved a pet, especially a cat.
- The injury involved a wild animal.
- The injury is due to a bite, either human or animal.
- The wound has debris stuck in it after cleansing.
- The wound is bleeding heavily.
- The wound will not stop bleeding after applying direct pressure for 10 minutes.
- The injury is a puncture wound.

Head injuries

Injuries to the head need to be treated with particular care. Any evidence of following symptoms may indicate serious injury and an ambulance must be called.

- unconsciousness, or lack of full consciousness (i.e. difficulty keeping eyes open);
- confusion
- strange or unusual behaviour – such as sudden aggression
- any problems with memory;
- persistent headache;
- disorientation, double vision, slurred speech or other malfunction of the senses;
- nausea and vomiting;
- unequal pupil size;
- pale yellow fluid or watery blood coming from ears or nose;
- bleeding from scalp that cannot quickly be stopped;
- loss of balance;
- loss of feeling in any part of body;
- general weakness;
- seizure or fit.

Hospital Admission

Where a pupil is required to attend hospital using an ambulance it is not necessary to accompany a pupil to hospital. If parents are unable to attend hospital promptly, a member of staff should go to the hospital. In the exceptional circumstance of parental permission being required, the Senior Teacher can act in loco parentis.

If a child is taken directly to hospital they will be accompanied by a member of staff who will stay with the pupil until discharged or until a handover can be made to a parent or guardian.

The member of staff at the hospital must update the senior teacher on the condition of the injured pupil as and when information is made available.

The parent/guardian of a pupil attending hospital must be advised at the earliest opportunity.

Support for the injured pupil and their parents will be provided as determined by the individual circumstances of the incident.

Blood and Body Fluid Spillages

It is important that spillages of blood, faeces, vomit or other body fluids are dealt with immediately as they pose a risk of transmission of infection and disease, e.g. blood born viruses and diarrhoeal and vomiting illnesses, such as norovirus.

Spillage Procedure

Body fluid spillages should be dealt with as soon as possible with ventilation of the area. Anyone not involved with the cleaning of the spillage should be kept away from the area and protective clothing should be worn when dealing with the spillage such as gloves and aprons.

In the event of a spillage, cordon off the area where the spillage has occurred.

Cuts and abrasions on any areas of the skin of the cleaner should be covered with a waterproof dressing. Disposable gloves and apron must also be worn, and if necessary use additional personal protective equipment and clothing to protect the body and clothes.

Hard surfaces e.g. floor tiles, impervious table tops.

In the event of small spills or splashes of blood, clean with neutral detergent and hot water.

Large spills

In the event of a large spill of blood, faeces or other bodily fluid:

- Remove the spillage as much as possible using absorbent paper towels
- Flush these down the toilet or dispose of them carefully in waste bag
- Cover any remaining spillage with paper towels soaked in diluted bleach solution (1:10 dilution with cold water)
- Leave the paper towels in place for up to 30 minutes, and then clear them away.

Alternatively, large spills may be covered with granules from the spillage kit for two minutes. The spillage and the granules should be carefully removed with paper towels and disposed of carefully into a waste bag.

Clean area with neutral detergent and hot water once either procedure has been completed.

Soft surfaces and fabrics e.g. carpets and chairs

For spills on soft surfaces and fabrics:

- Remove the spillage as far as possible using absorbent paper towels,
- Clean with a fresh solution of neutral detergent and water, and
- Carpets and upholstery can then be cleaned using a suitable cleaning product. Steam cleaning may be considered if necessary.

Contaminated gloves, aprons, paper towels, etc should be carefully disposed of into a leak proof plastic bag, securely tied and placed immediately into the normal external school waste container. Large quantities of contaminated waste should be disposed of in consultation with the local waste authority.

All employees should wash their hands after taking part in any of the above procedures.

As with other all hazardous substances used in school, bleach and disinfectants should be stored, handled and used in accordance with the Control of Substances Hazardous to Health (COSHH) Regulations and the manufacturer's instructions. Product data sheets and safe use instructions should be easily accessible, along with risk assessments and details of actions required in the event of accidental ingestion, inhalation or contact with skin or eyes.

All chemicals must be stored in their original containers, in a cool, dry, well-ventilated place that is lockable and inaccessible to children, visitors and the public.

Appropriate protective clothing (e.g. gloves and aprons) should be worn when handling bleach and other chemical disinfectants. Contact with skin, eyes and mouth should be avoided at all times when handling or using them.

Gas Installations and Appliances

The school will ensure that all work carried out on gas fittings and appliances are in accordance with the requirements of the regulations and the Safety in the Installation and Use of Gas Systems and Appliances Manual.

Gas Emergencies

In the event of a suspected gas leak:

1. Call 24 hour gas emergency service on 0800 111 999
2. Evacuate the buildings and move the pupils and majority of the staff to a distance of at least 250 metres away. Nominate some staff to stay at a safe distance to prevent access to the site and await the emergency National Grid engineer.
3. If it is safe to do so:
 - Put out naked flames
 - Open doors and windows
 - Turn off the gas supply.

DO NOT TURN ELECTRICAL SWITCHES ON OR OFF

4. If the general public in the neighbourhood are at risk contact the police on 999

No person shall interfere with any gas appliance or gas fitting or pipe work unless qualified and competent to do so.

Hazardous Substances (COSHH)

All reasonable steps will be taken to ensure all exposure of staff and pupils to substances hazardous to health is prevented or at least controlled to within statutory limits.

The school will give sufficient information and training to ensure full understanding of the hazards to health posed by substances in the workplace and the importance of the control measures provided. Information will also be given to others who may be affected such as contractors, temporary staff and visitors where appropriate.

Staff should **not** use any hazardous substance unless they have received the information and training for the safe use of that substance.



There are a range of hazardous substances to which the regulations apply. These include:

- those classified and shown with warning label
- substances with Occupational Exposure Limits
- biological agents e.g. Legionella bacteria
- any kind of dust
- substances generated by work processes e.g. various bacteria/viruses from bodily fluids
- premises with covered or underground parking that may expose people to vehicle exhaust fumes and some manufacturing and cleaning processes that may give off dusts, vapours or fumes.







Hazard Labelling

Hazardous substances may be defined as being very toxic, toxic, corrosive, harmful, sensitising, irritant, carcinogenic, mutagenic or toxic for reproduction.









Classification of hazardous substances is currently done under the Classification Labelling and Packaging (CLP) Regulations, which came into full effect in June 2015. These Regulations require hazardous substances to be packaged and labelled to an internationally agreed standard. However, hazardous substances which have already been packaged and placed on the market do not have to be removed from the supply chain until 1st June 2017. This means that hazardous substances can be found packaged using symbols from the old European standard until that date.

Hazardous substances can be readily identified by their label:

European system (pre-June 2015)

	Harmful / Irritant		Corrosive		Toxic		Flammable
	Oxidising		Explosive		Dangerous to the Environment		

International system (current standard)

	Harmful / Irritant		Corrosive		Toxic
	Flammable		Oxidising		Harmful to the environment
	Carcinogenic / mutagenic		Explosive		Gases under pressure

Hazardous substances that are generated by work processes are not as easily identifiable as they do not come conveniently labelled.

Exposure Routes

Exposure to hazardous substances may be via:

- inhalation e.g. dust/particulate or vapours/fumes
- contact with eyes or cuts
- absorption through the skin
- ingestion
- injection.

Hazard Effects

Effects on health may be short-term or long-term and will generally vary according to levels and duration of exposure. Effects of substances also vary with some having an accumulative effect and some that will have only temporary health effects.

Control Principles

The principles applied to substances to control exposure are:

1. elimination e.g. don't use the substance
2. substitution e.g. a less hazardous substances
3. engineering controls e.g. Local Exhaust Ventilation
4. information, instruction, supervision and training
5. Personal Protective Equipment (PPE) e.g. gloves, glasses, overalls.

Working with Hazardous Substances

Prior to working:

- ensure you understand the risks of working with any hazardous substances and the controls in place
- ensure you know the location of the material safety data sheets and risk assessments
- ensure the controls specified in the risk assessment, including any items for emergencies are:
 - in place
 - fully operational
 - available.
- ensure you understand how to operate or use any control measures safely and have received training prior to starting work.

Whilst working

- ensure regular check controls are effective
- clean up any spillages etc
- report any problems or defects immediately to your manager
- report any ill-health or accidents to your manager.

Infection Control

School staff and pupils are from time to time at risk of infection or of spreading infection.

The school aims to minimise the risk of the spread of infection and will implement appropriate policies and procedures.

Staff Illness and Reporting

Staff should notify the Principal if they develop any of the following infectious diseases or symptoms:

- skin infections or exposed areas of infestation
- severe respiratory infection (e.g. pneumonia, TB)
- severe diarrhoea
- jaundice
- hepatitis
- Chicken Pox, Measles, Mumps, Rubella
- HIV

Principals will need to discuss with the individual suitable controls. In some cases, employees may need to be referred to an Occupational Health Practitioner or their GP for advice.

Staff should report diseases including Leptospirosis, Hepatitis, TB, and Tetanus which have been contracted through work as these are reportable under RIDDOR (Reporting of Injuries, Diseases and Dangerous Occurrences Regulations).

Confidentiality

Confidentiality will be maintained at all times in relation to an employee who is known to have any infectious disease.

No health information will be disclosed without the written consent of the employee concerned and any breach of such confidentiality, either inside or outside the organisation, will be regarded as a disciplinary offence and may result in disciplinary action.

Interactive Whiteboards

All reasonable steps will be taken by the school to secure the health and safety of employees and pupils when interactive whiteboards are used.

Guidance for Users

- teachers and pupils should avoid staring into the projector beam at all times
- try to keep your back to the beam as much as possible
- use the stick or laser pointer provided whenever possible.

Ladders and Stepladders

This guidance is to help you:

- know when to use a ladder
- decide how to go about selecting the right sort of ladder for the particular job
- understand how to use it
- know how to look after it
- take sensible safety precautions.

When is a ladder the most suitable access equipment?

As a guide, **only** use a ladder or stepladder:

- in one position for a maximum of 30 minutes
- for 'light work' - they are not suitable for strenuous or heavy work. If a task involves you carrying more than 10 kg (a bucket of something) up the ladder or steps it will need to be justified by a detailed manual handling assessment
- where a handhold is available on the ladder or stepladder
- where you can maintain three points of contact (hands and feet) at the working position.

On a **ladder** where you cannot maintain a handhold, other than for a brief period of time, other measures will be needed to prevent a fall or reduce the consequences of one. On **stepladders** where a handhold is not practicable you will need to consider whether it is safe to work or not.

Is it a safe place to use a ladder or stepladder?

As a guide, **only** use a ladder or stepladder:

- on firm ground or spread the load (e.g. use a board)
- on level ground - for stepladders refer to the manufacturer's instructions, for ladders the maximum safe ground slopes on a suitable surface (unless the manufacturer states otherwise) are as follows:
 - side slope 16° – but the rungs still need to be levelled
 - back slope 6°.
- on clean, solid surfaces (paving slabs, floors etc). These need to be clean (no oil, moss or leaf litter) and free of loose material (sand, packaging materials etc) so the feet can grip. Shiny floor surfaces can be slippery even without contamination.

Never stand ladders or stepladders on moveable objects, such as pallets, bricks, lift trucks, tower scaffolds, vans, stacks of paper or boxes etc. If the ladder or stepladder won't reach, you need to use a more suitable type of access equipment.

You should **only** use ladders or stepladders:

- where they will not be struck by vehicles, by protecting them with suitable barriers or cones
- where they will not be pushed over by other hazards such as doors or windows, by securing doors (not fire exits) and windows where possible. If this is impractical, have a person standing guard at a doorway, or inform building occupants not to open windows until they are told it is safe to do so

- where pedestrians are prevented from walking under them or near them, by using barriers, cones or, as a last resort, a person standing guard at the base.

Safety in use – ladders

On a ladder **do not**:

- overload it – you and anything you are carrying should not exceed the highest load stated on the ladder
- overreach - keep your navel inside the stiles and both feet on the same rung throughout the task
- rest ladders against weak upper surfaces e.g. glazing or plastic gutters. Use effective spreader bars instead
- use the top three rungs
- move the ladder while someone is using it
- extend a ladder while standing on the rungs
- slide down the stiles.

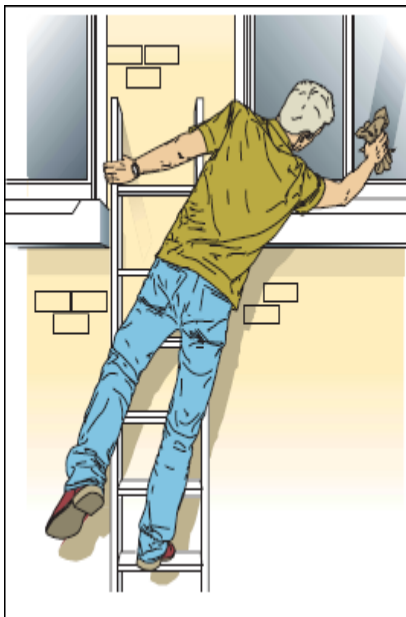

Overreaching – not maintaining 3 points of contact



Maintaining 3 points of contact

Do:

- make sure the ladder rungs are level. This can be judged by the naked eye. Ladders can be levelled using specially designed devices but not by using bits of brick or whatever else is at hand
- check that the weather is suitable - do not use ladders in strong or gusting winds
- wear sensible footwear. Shoes should not have the soles hanging off, have long or dangling laces, or be thick with mud or other slippery contaminants. High heels are also unsuitable!

- check that you are fit. Certain medical conditions or medication, or a fear of heights, could mean that you shouldn't be working at height
- know how to tie a ladder properly.

You should also avoid holding items when climbing (for example by using tool belts). If you must carry something you must still have one free hand to grip the ladder. Remember the **THREE POINTS OF CONTACT RULE** – 2 hands and 1 foot or 2 feet and 1 hand **MUST BE** on the ladder at all times when climbing and descending.

Ladders must be erected at an angle of 75°. To judge the angle use the angle indicator marked on the stiles of some ladders or the 1 in 4 rule (1 unit out for every 4 units up).

Ladders used for access to another level must be tied and should extend at least 1 metre above the landing point to provide a secure handhold.

Correct 1 in 4 angle:

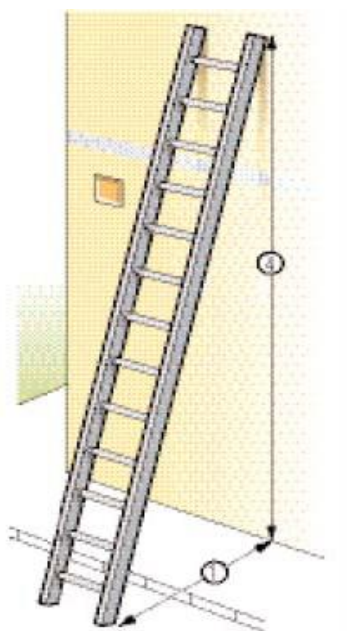

Securing a ladder

To prevent the ladder slipping away from the wall, or slipping sideways, you must secure it. The options for securing a **ladder** are:

- tie the ladder to a suitable point, making sure both stiles are tied
- where this is not practical, use a safe, unsecured ladder or a ladder supplemented with an effective ladder stability device
- if this is not possible, then securely wedge the ladder e.g. against a wall
- if none of the above can be achieved, foot the ladder. Footing is the last resort and other methods of securing the ladder should be used in preference.

If you do have to foot a ladder, be aware that this will not stop a ladder slipping sideways at the top. Individuals footing ladders should apply weight downwards on the ladder by standing on a rung, or by pushing against the ladder stiles (although this is less effective).

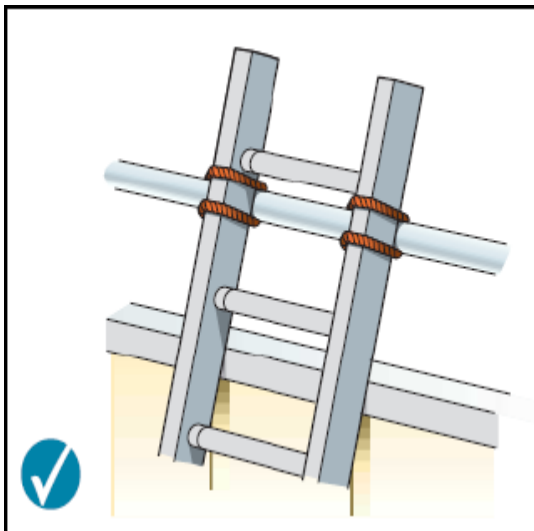

Ladder tied at the top stiles (correct for working on, but not for access)

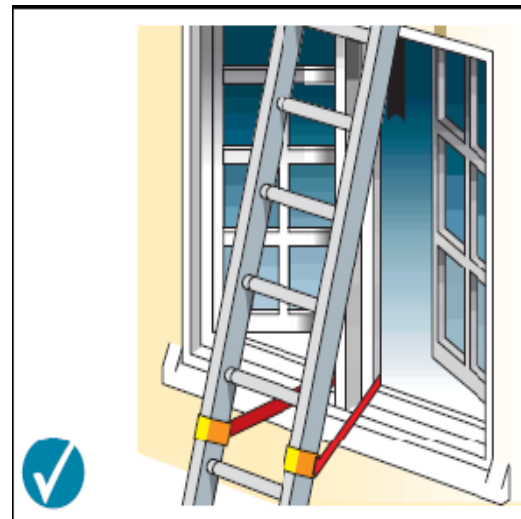

Tying part way down



Tying near the base

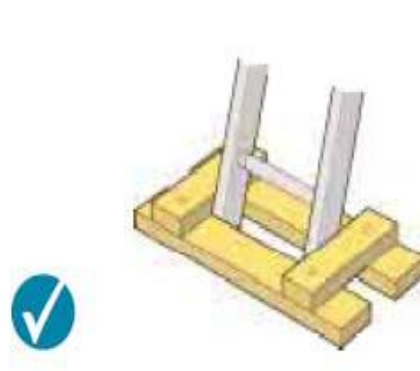

Securing at the base

Safety in use – stepladders

On a stepladder **do not**:

- overload it – you and anything you are carrying should not exceed the highest load stated on the stepladder
- use it in locations where the restraint devices cannot be fully opened. Any locking devices must also be engaged
- use the top two steps of a stepladder, unless a suitable handrail is available on the stepladder
- use the top three steps of swing-back or double-sided stepladders, where a step forms the very top of the stepladder.

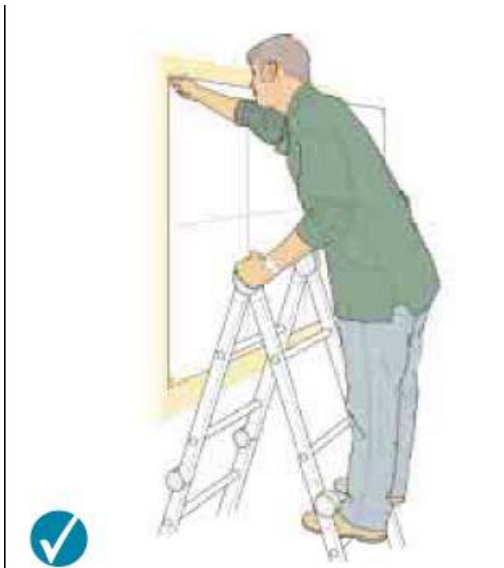

Correct – two clear rungs. Don't work any higher up this type of stepladder.

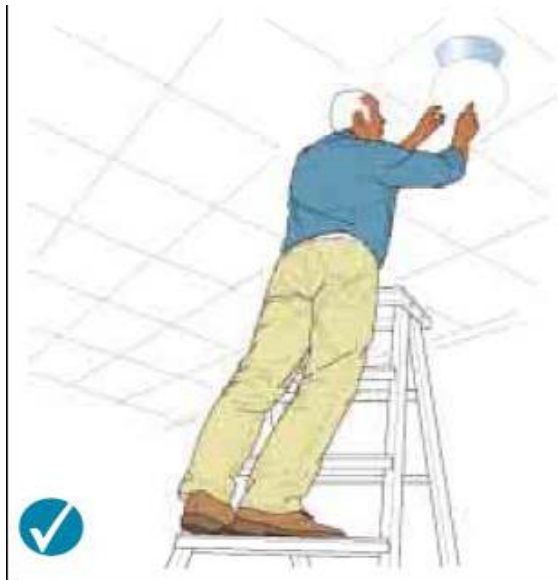

Correct – 3 clear rungs, do not work any higher on this type of stepladder

When using stepladders, avoid work that imposes a side loading, such as side-on drilling through solid materials (e.g. bricks or concrete), by having the steps facing the work activity. Where side-on loadings cannot be avoided you should prevent the steps from tipping over, for example by tying the steps to a suitable point, or you should use a more suitable type of access equipment.



Incorrect – steps side on to work activity



Correct – steps facing work activity

Where you cannot maintain a handhold (e.g. putting a box on a shelf), the use of a stepladder will have to be justified by taking into account:

- the height of the task
- a safe handhold still being available on the stepladder
- whether it is light work
- whether it avoids side loading
- whether it avoids overreaching
- whether your feet are fully supported
- whether you can tie the stepladder.

Consider tying a **stepladder** where possible and helpful to the task (e.g. side-on working or where two free hands are needed). Stepladders should not be used for access to another level unless they have been designed for this.

Is the ladder or stepladder safe to be used?

You must check that the ladder or stepladder is in a safe condition before using it (a daily pre-use check). As a guide, **only** use ladders or stepladders that:

- have no visible defects
- have a current detailed visual inspection (look for an inspection label)
- are suitable for work use. Use Class 1 or EN 131 ladders or stepladders at work because domestic (Class 3) ones are not normally suitable for use at work
- have been maintained and stored in accordance with the manufacturer's instructions.

Also, you must always use a non-conductive ladder or steps for any necessary live electrical work.

Pre-use checks

Look for obvious visual defects before using a ladder or stepladder. Check that:

- all the ladder feet are fitted
- the feet are in good repair (not loose, missing, splitting, excessively worn, secure etc)
- the feet are clean - the feet should be in contact with the ground. Ladder feet should also be checked when moving from soft/dirty ground (e.g. dug soil, loose sand/stone, a dirty workshop) to a smooth, solid surface (e.g. paving slabs), to ensure the foot material and not the dirt (e.g. soil, embedded stones or swarf) is making contact with the ground
- all the screws, bolts and hinges are secure
- on a stepladder, that the "spreaders" on the ladder can be locked into place
- There are no other obvious signs of damage such as cracks.

If you find a problem, **DO NOT USE** the ladder. It should be repaired (if practicable) or destroyed

Storage

When storing ladders and stepladders, store them in a well ventilated area to prevent sagging and warping. Store straight ladders in flat racks or on wall brackets, don't hand them from the rungs. Store step ladders in the closed, vertical position.

The information in this Guidance is based on the HSE leaflet 'Safe use of ladders and step ladders'.

Legionnaires Disease

All reasonable steps will be taken to identify potential legionellosis hazards and to prevent or minimise the risk of exposure.

At risk systems include the hot and cold water storage and distribution system. To achieve control of legionella bacteria the school will implement measures to ensure any growth of the bacteria is kept to a minimum and systems maintained.

Day to day responsibility for monitoring and ensuring that the systems are being correctly operated lies with the Bursar and any problems should be reported to them.

Lone Workers

Rules for lone workers

- Anyone working alone must have access to a telephone and ensure that a relative or colleague is aware;
- The caretaker (or other named person) must be informed of anyone intending to work late and a satisfactory arrangement made for locking up the building;
- When the caretaker (or other named person) is not present all lone workers, for reasons of security, health and safety, should lock themselves in the building.
- Staff must not place themselves in danger by challenging intruders or vandals but should call the police for assistance.
- Staff working alone have a responsibility for making themselves familiar with and following the school's safety procedures and location of safety equipment.
- If staff rely on mobile phones they must ensure that their network has good reception within school. Although phones can give extra reassurance, they do not provide complete protection and staff should still be alert for their own personal safety at all times.
- In the situation where two or more people are working in isolated areas of an otherwise unoccupied building, personnel should keep each other informed about their movements.

Opening/Closing School

- When the last person has left the building and notified the caretaker (or other named person), he should then secure the building. This includes the closing of all fire doors and leaving on any emergency and exterior lights.
- When the caretaker (or other named person) arrives in the morning he must make a quick examination of the exterior of the building to make sure that there are no signs of a break-in or of anyone having been in the building. If the caretaker is in any doubt he should contact the Police/security firm and should never enter the building if he is unsure of his safety.
- Key holders are also advised to inform someone when they are attending an alarm call out.

Emergency Considerations

Lone workers should be capable of responding correctly to emergencies. Risk assessment should identify foreseeable events. Emergency procedures should be established and the people concerned trained in using the procedures.

Emergency Procedures may need to cover:

- fires resulting from the activity or work being undertaken
- if a person has an accident what needs to be done to recover them, especially important in laboratories
- actions to be taken in case of a chemical spill
- actions to be taken in the event of power failure (for example where the person is reliant on power for their safety systems or for egress from a building e.g. power operated doors).

Manual Handling

Unnecessary or incorrect handling can cause injury, in particular to the back.

Do not try to lift anything beyond your individual capability and before ascertaining weight, stability and centre of gravity.

The correct handling technique required to lift items safely is demonstrated below:

1 Planning

Plan the lift, consider where the load is to be placed, the distances involved; are there any obstructions such as closed doors, is assistance required and can handling aids or equipment be used?

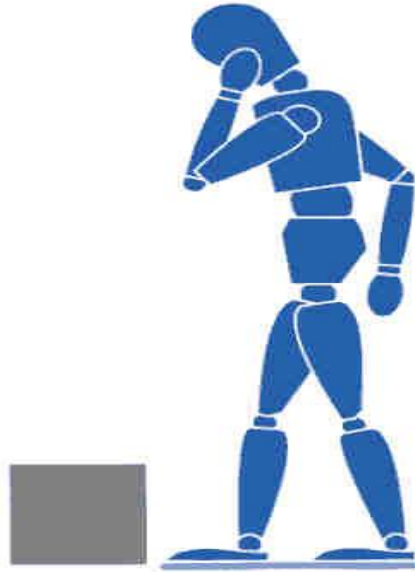

2 Feet

The feet should be positioned apart (shoulder width), one foot ahead of the other in the direction of the intended movement

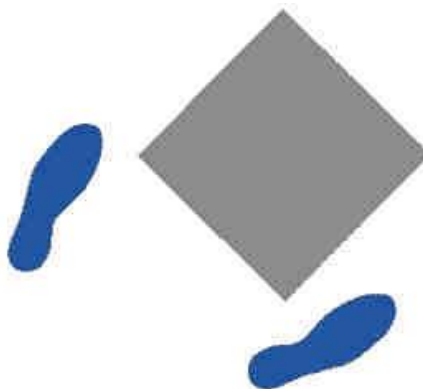

3 Knees

Adopt a good posture for handling with the knees bent (not squat – don't kneel), in order to gain the most effective power from the thigh muscles

4 Back

The back should be straight - not necessarily vertical (15° - 20° from vertical is alright) keeping the natural curve of the spine. It may help to tuck in the chin. If necessary, lean forward a little over the load to get a good grip and to keep the centre of gravity over the load.

5 Arms

The arms should be close to the body (nearer the centre of gravity) with the shoulders level and facing the same direction as the hips.



6 Hands

Ensure a firm grip on the load. Holding the load this way is also less tiring than keeping the fingers straight.

7 Head

Raise the chin out and up as the lift begins, otherwise this results in round shoulders and a curved spine.

8 Moving the load

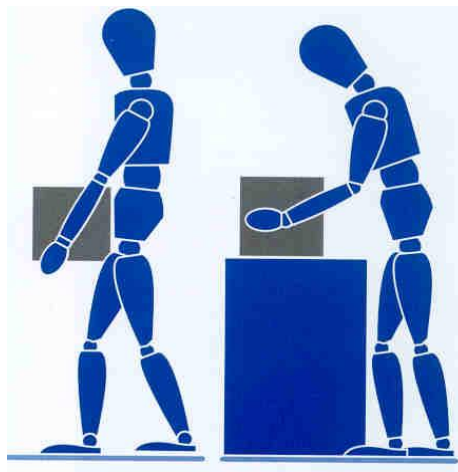

- Keep the load as close to the trunk for as long as possible, and where relevant, keep the heaviest side of the load close to the body. Slide the load towards you if required.
- Lift smoothly
- Move the feet not the trunk when turning to the side, i.e., don't twist.
- Put the load down and then slide the load into the required position if necessary.

9 Team Handling

Handling by two or more people may make possible an operation that is beyond the capability of one person, or reduce the risk of injury to a solo handler.



Additional difficulties may arise if team members impede each other's vision or movement, or if the load offers insufficient good handholds. This can occur particularly with compact loads which force the handlers to work close together or where the space available for movement is limited.

When lifting loads at or near floor level is unavoidable, handling techniques which allow the use of relatively strong leg muscles rather than those of the back are preferable, provided the load is small enough to be held close to the trunk. In addition, if the task includes lifting to shoulder height, allow the handlers to change hand grip. Bear in mind, however, that such techniques impose heavy forces on the knees and hip joints which must carry both the weight of the load and the weight of the rest of the body.

The closeness of the load to the body can also be influenced by foot placement. The elimination of obstacles which need to be reached over or into will permit the handler's feet to be placed beneath or adjacent to the load before beginning the manual handling operation.

Needlestick or Sharps Injuries

A needlestick or sharps injury is when the skin is punctured or scratched by a needle or sharp device that may be contaminated. Needles will most commonly be found in adrenaline auto-injectors (known as EpiPens) or other medication prescribed to pupils or staff in an auto-injector. Needles, sharps and other waste or drug paraphernalia may also be illicitly brought on site by pupils, or be dumped on site by members of the public in an attempt to covertly dispose of it. As such, staff should be aware of the hazards posed by needles, sharps and similar waste.

The direct handling of needles should be avoided. If this is not possible pick up the needle by the thick end wearing gloves. The needle should then be placed in an appropriate container for disposal. A used EpiPen or other auto-injector for medication should be treated in the same way even if it incorporates a mechanism for automatically re-sheathing the needle after use.

If you suffer an injury from a needlestick or sharp which may be contaminated you must:

- encourage the wound to gently bleed, ideally holding it under running water
- wash the wound using running water and plenty of soap
- don't scrub the wound whilst you are washing it
- don't suck the wound
- dry the wound and cover it with a waterproof plaster or dressing
- seek medical assistance as advised by the Welfare Officer
- report the injury to your line manager.

New and Expectant Mothers

The school recognises that the general precautions taken to protect the health and safety of the workforce as a whole may not in all cases protect new and expectant mothers and there may be occasions when, due to their condition, different and/or additional measures will be necessary.

Should you become pregnant or are returning to work after having a baby, then you are requested to notify your Principal at the earliest possible opportunity so a risk assessment can be carried out.

Any necessary control measures will be implemented and reviewed regularly. Where risks cannot be eliminated or reduced to an acceptable level then consideration will be given to adjusting working conditions and/or hours or if necessary providing suitable alternative work or suspension with pay.

New or expectant mothers should inform their Principal of any changes which may affect the risk assessment including any medical conditions, incidents etc.

Personal Protective Equipment

The school provides personal protective equipment (PPE) when the risk presented by a work activity cannot be eliminated or adequately controlled by other means. When it is provided, it is because health and safety hazards have been identified that require the use of PPE and it is therefore necessary to use it in order to reduce risks to a minimum.

Employees and volunteers provided with PPE must:

- wear the PPE as instructed or where indicated by signage
- maintain it in good condition
- report any defects to your manager
- ensure the PPE fits correctly, is comfortable and fully adjusted.



Safeguarding

All education professionals, including administrative and facilities staff as well as teaching staff, have a statutory duty of care to all pupils. This duty extends to promoting the welfare of pupils who require additional support but are not suffering harm or at immediate risk of harm.

The school will promote awareness and best practice to deal with situations of suspected abuse or neglect and situations in which staff are best placed to observe such signs.

Staff Responsibilities

The school requires all staff to:

- assist in providing a safe environment in which children can learn
- raise all concerns with the designated safeguarding lead, including concerns about other staff members
- always err on the side of caution and report suspected cases of abuse or neglect
- report concerns directly to children's social care if it is not possible to raise them with the designated safeguarding lead
- always act in the best interests of the child.

If at any point there is a risk of immediate serious harm to a child, staff members should make an immediate referral to children's social care. If the child's situation does not improve, staff members with concerns should press for re-consideration.

Record Keeping

We will ensure that appropriate, accurate, legible and contemporaneous records of safeguarding concerns are made and stored securely in accordance with the Data Protection Act 1998.

Smoking

Exposure to second-hand smoke, also known as passive smoking, increases the risk of lung cancer, heart disease and other illnesses. Ventilation or separating smokers and non-smokers within the same airspace does not stop potentially dangerous exposure.

It is the policy of the school that all of its premises are smoke-free and that all staff and pupils have a right to work in a smoke-free environment.

Smoking is prohibited throughout the entire school, including the use of all artificial smoking aids (electronic or otherwise) with no exceptions. This policy applies to all employees, pupils and visitors in all areas of the school, including school vehicles.



Implementation

All staff are obliged to adhere to and facilitate the implementation of the policy.

The school will ensure that all staff and contractors are aware of the policy on smoking. They will also ensure that all new personnel are given a copy of the policy on recruitment or induction.

Appropriate 'no smoking' signs will be clearly displayed at or near the entrances to the premises. Signs will also be displayed in school vehicles that are covered by the law.

Stress

The Health and Safety Executive define stress as “the adverse reaction people have to excessive pressure or other types of demand placed on them”. This makes an important distinction between pressure, which can be a positive state if managed correctly, and stress which can be detrimental to health.

Stress at work can come about for a variety of reasons. It may be excessive workload, unreasonable expectations, or overly-demanding work colleagues. As a reasonable school, we try to ensure that you are in a pleasant working environment and that you are as free from stress as possible.

Employees who experience unreasonable stress which they think may be caused by work should raise their concerns with their manager or through the school’s grievance procedure. If deemed appropriate, the school will provide access to confidential counselling for staff affected by stress caused either by work or external factors

Following action to reduce the risks, they shall be reassessed. If the risks remain unsustainable by the member of staff concerned, efforts shall be made to reassign that person to other work for which the risks are assessed as tolerable.

Supporting Pupils with Medical Needs

The school’s policy is to support pupils to attend school who have a medical condition. The school will therefore support the administration of short and long term medication and medical techniques where this is necessary for the pupil to continue to be educated at school. The school will also put in place procedures to deal with emergency medical needs.

The school will establish procedures to ensure that all concerned, staff, parents, pupils and, where relevant, health professionals are aware of the pupil’s condition and what steps have been agreed either to manage the condition on a daily basis or to be implemented in case of an emergency.

Individual health care plans are in place for those pupils with significant medical needs e.g. chronic or ongoing medical conditions such as diabetes, epilepsy, anaphylaxis etc. These plans will be completed at the beginning of the school year / when child enrolls / on diagnosis being communicated to the school and will be reviewed/updated annually.

Administering Medicines

No child under 16 should be given medicines without their parent’s written consent. Any member of staff giving medicines to a child should check: the child’s name; prescribed dose; expiry date; written instructions provided by the prescriber on the label or container.

If in doubt about any procedure staff should not administer the medicines but check with the parents or a health professional before taking further action. If staff have any other concerns related to administering medicine to a particular child, the issue should be discussed with the parent, if appropriate, or with a relevant health professional.

Self-Management

It is good practice to support and encourage children, who are able, to take responsibility to manage their own medicines from a relatively early age. As children grow and develop they should be encouraged to participate in decisions about their medicines and to take responsibility.

Where children have been prescribed controlled drugs, staff need to be aware that these should be kept safely. However children could access them for self-medication if it is agreed that it is appropriate.

Refusing Medicines

If a child refuses to take medicine, staff should not force them to do so, but should note this in the child's record and follow the agreed procedures. Parents should be informed of the refusal on the same day.

Educational Visits

The school will consider what reasonable adjustments they might need to make to enable children with medical needs to participate fully and safely on visits. This might include reviewing and revising the visits policy and procedures so that planning arrangements will include the necessary steps to include children with medical needs. It might also include risk assessments for such children.

Sometimes additional safety measures may need to be taken for outside visits. It may be that an additional supervisor, a parent or another volunteer might be needed to accompany a particular child. Arrangements for taking any necessary medicines will also need to be taken into consideration. Staff supervising visits should always be aware of any medical needs and relevant emergency procedures. Copies of health care plans should be taken on visits in the event of the information being needed in an emergency.

Sporting Activities

Any restrictions on a child's ability to participate in PE should be recorded in their individual health care plan. All adults should be aware of issues of privacy and dignity for children with particular needs.

Some children may need to take precautionary measures before or during exercise and may also need to be allowed immediate access to their medicines such as asthma inhalers. Staff supervising sporting activities should consider whether risk assessments are necessary for some children, be aware of relevant medical conditions and any preventative medicine that may need to be taken and emergency procedures.

School Transport

Where pupils have life threatening conditions, specific health care plans should be carried on vehicles. The care plans should specify the steps to be taken to support the normal care of the pupil as well as the appropriate responses to emergency situations.

All drivers and escorts should have basic first aid training. Additionally trained escorts may be required to support some pupils with complex medical needs. These can be healthcare professionals or escorts trained by them.

Some pupils are at risk of severe allergic reactions. Risks can be minimised by not allowing anyone to eat on vehicles. All escorts should also be trained in the use of an adrenaline pen for emergencies where appropriate.

Non Prescription Medication

Non prescription medication should not be administered by school. This includes paracetamol and homeopathic medicines.

Staff may not know whether the pupil has taken a previous dose, or whether the medication may react with other medication being taken. **A child under 16 should never be given aspirin containing medicine, unless prescribed by a doctor.**

Where it is necessary to administer non-prescription medicine to a child, specific written permission must be obtained from parents / carers and the administration documented.

If a pupil suffers regularly from acute pain, such as migraine, the parents should authorise and supply appropriate painkillers for their child's use, with written instructions about when the child should take the medication. A member of staff should notify the parents that their child has requested medication and supervise the pupil taking the medication if the parents have agreed to it being taken.

Temporary Staff and Volunteers

The school will take the necessary measures to ensure the health and safety of any temporary and volunteer staff in its employment.

To achieve this, the school will provide temporary or volunteer staff with the following information prior to starting work:

- details of the qualifications and skills required to do the work safely
- the requirements of the safeguarding policy
- a risks to health and safety identified by workplace risk assessments
- the preventive measures to be taken
- safe working procedures
- the action to be taken in the event of an emergency.

The competence of temporary and volunteer staff will be assessed to ensure they are capable of working safely.

Trainee teaching staff or pupil teachers are additionally required to complete the proper DBS checks and to assist with implementing the school's safeguarding policy during their work.

Training

Training in health and safety is a legal requirement and also helps create competent employees at all levels within the school to enable them make a far more effective contribution to health and safety, whether as individuals, teams or groups.

All employees will receive **induction training**.

Such training will cover:

fire procedures, warning systems, actions to be taken on receiving warning, locations of exits/escape routes, evacuation and assembly procedures, first aid/injury reporting procedures, names of first aiders/appointed persons, instruction on any prohibition areas (i.e. no smoking), issue of protective clothing/equipment and its use, instruction under COSHH, mandatory protection areas, thorough instruction applicable to their particular duties at work etc.

Training needs will be reviewed as a result of job changes, promotion, new activities or new technology, following an accident/incident and performance appraisal.

Records of training will be kept for all employees.

Employees must:

- participate in the induction training activities they have been required to attend or carry out
- work according to the contents of any training they receive
- ask for clarification of any points they do not fully understand
- not operate hazardous plant or equipment, use hazardous chemicals or carry out any hazardous activity unless they have been appropriately trained and instructed.

Violence to Staff

The school recognises that in certain situations violent behaviour towards staff may occur and therefore will take all reasonable measures to protect staff from violence and aggression.

We define violence and aggression as:

- actual or threatened physical assaults on staff
- psychological abuse of staff
- verbal abuse which includes shouting, swearing and gestures
- threats against employees.

If you are a witness or receive any violence or aggression towards you, then you should report this to a senior member of staff / your manager so that this can be recorded and investigated. The school will support the decision of any employee wishing to press charges against the individual(s) involved. Access to counselling can also be provided where required.

Visitors

In the interest of safety and security, the school will take the necessary measures to protect staff and visitors from any accidents or incidents that may occur during visiting.

Employees hosting visitors must ensure that:

- they are authorised to enter the premises or are accompanied
- they adhere to applicable health and safety instructions and rules during their visit
- adequate information is passed to ensure their safety including emergency information
- any protective clothing required is provided and worn
- any accidents / incidents involving visitors are reported through the accident reporting arrangements.

Employees aware of people on the premises who may be unauthorised should report these to their manager for action.

Emergency Action

In the event of the fire alarm sounding, all visitors should be escorted to the assembly point by their host. Visitors should not leave the area before notifying the senior person present.

Work At Height

The school will take all reasonable steps to provide a safe working environment for all employees who may be affected by work at height activities.

Using Ladders (including stepladders)

Ladders and stepladders should only be used for short duration tasks (less than 30 minutes), light duty tasks or where more suitable access equipment cannot be used due to existing features of the site which cannot be altered.

Only those persons who have been trained to use ladders safely may use them.

Prior to use it should always be ensured that the ladder is in good condition and fit for purpose.

Where ladders are to be used to work from it should be ensured that:

- a) a secure handhold and support are available at all times;
- b) the work can be completed without stretching;
- c) the ladder can be secured to prevent slipping.

Under no circumstances should high areas be accessed using chairs, tables or such other items of furniture not designed the purpose.

Work Equipment

The school will provide a safe working environment in relation to work equipment safety and ensure all employees receive appropriate safety information and training in their work equipment.

Employees must

- only use work equipment for which they have received information and training for
- not undertake any maintenance work unless competent and authorised to do so
- not interfere with or remove anything which has been provided for safety reasons
- report defects immediately to their manager/supervisor
- use any personal protective equipment as required.

HEALTH AND SAFETY HANDBOOK ACKNOWLEDGEMENT FORM

Please read the notes below and then sign this form.

Clearly, we will do all in our power to ensure the health and safety and welfare of all our staff and we look to our employees to abide by the Health and Safety standards laid down.

We have formulated our Health and Safety at Work Policy as legally required and this handbook informs you of those sections of the Policy which affect you.

You should read the information contained in this Handbook and adhere to the rules at all times.

Please discuss any queries you may have with your employer and sign this form.

I have read the Health and Safety Handbook and understand and accept its contents. I will keep myself informed of its contents.

Signature: _____ Date: _____

Print Name: _____